

BriPower KGS Series

AC/DC Power Supply & Load

Features

- Modular design, output power from 15kVA to 1080kVA
- Bi-directional AC/DC power source, seamless transition between source and sink modes
- Independent three-phase output, which can be configured as single-phase output
- Regenerative AC/DC load function
- Output: AC, DC, AC+DC
- Max output 450V L-N within output frequency range from DC to 5kHz
- Frequency Range: DC~ 5kHz max
- Up to 100th harmonic waveform generation, inter-harmonic generation
- Trigger out, TTL signal output for voltage or frequency change
- AC output, ON/ OFF output phase angle can be programmed
- Using true current feedback control when working in CC mode
- RLC Load Simulation & RCD Load Simulation
- Bi-Polar DC Source (-BP option)
- Analog signal input for use as a power amplifier (delay $\leq 20 \mu\text{s}$)
- 30 Built-in harmonic waveforms
- Soft start: effectively restrain the impulse current when power on
- TFT-Touch panel operation
- Master-Slave interface
- LAN, RS485, Analog control interface

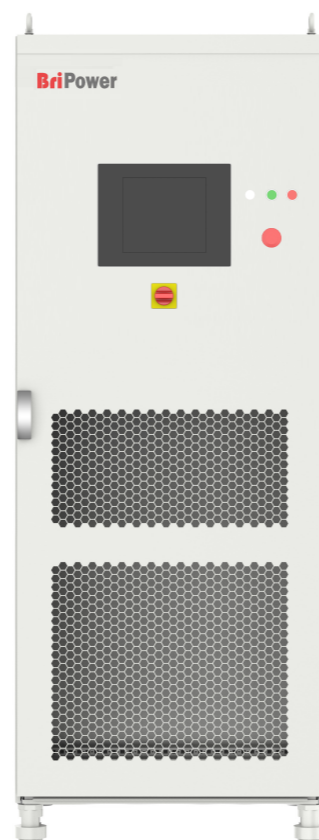

- Emergency stop button and indicators on front panel
- Mod-bus/ASCII protocols
- CE conformity
- 13 months warranty

Overview

The BriPower KGS series is a high-performance AC/DC power source/load, using SiC MOSFET PWM technology, which contains multi output power levels from 15kVA to 1080kVA. With an output frequency range from DC to 5kHz, max output 450V L-N.

KGS series uses bi-directional design, which makes it possible to be used as grid simulator to test distributed generation systems. KGS Series is well suited for aerospace applications. Remote control interfaces and SCPI command language are provided for easy integration into ATE systems.

KGS series adopts dual DSP+FPGA design, with powerful calculation and control capabilities, and can display and save measured values at 10k/s sampling. The KGS series adopts optical fiber communication and performs multiple monitoring and protection of all main components, communication connections and systems. It is a reliable power supply product.

With touch panel on the front panel, users can control the power source through GUI software. System status indicators and emergency stop button are installed on the front panel. RS485, LAN and analog control interfaces are available for automated test applications.

Grid Simulation

KGS series is comprehensive, fast dynamic grid simulator for distributed generation system testing, such as the electrical characteristics of energy storage PCS, PV inverter, etc. The simulation functions

include voltage and frequency fluctuation, voltage drop, high voltage ride through, low/zero voltage drop, three-phase unbalance, harmonic and inter-harmonic etc. The KGS series meets the requirements of grid tied DG regulations testing, such as: grid voltage abnormality test, grid frequency abnormality test, high voltage ride through test, low/zero voltage ride through test, anti-islanding test, etc. KGS series provides GUI software to simulate various real-world power grid operating conditions.

• **Voltage/frequency sequence programming**

The KGS series provides voltage and frequency sequence programming function. The parameters such as output voltage, frequency, slew rate, ON/ OFF output phase angle, duration time, switching time are programmable, and three phases are independent for settings.

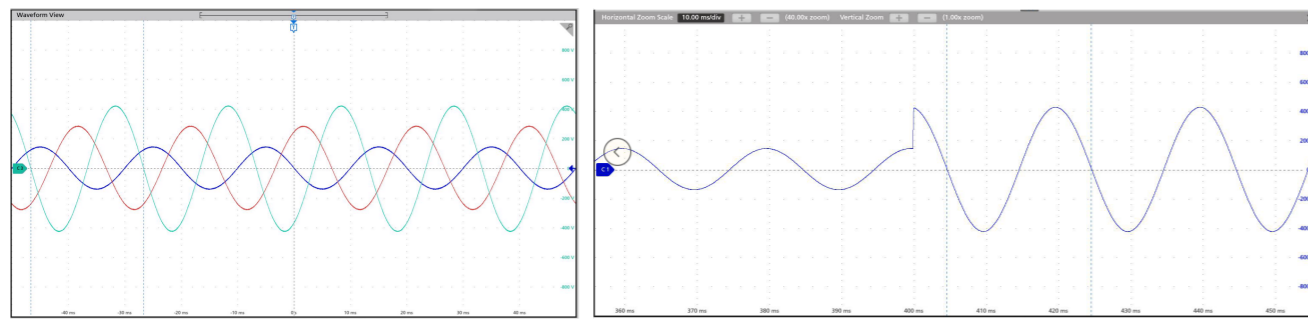

Three-phase Unbalance

Voltage change waveform @90°

• **Harmonic and inter-harmonic waveforms**

Dual DSP+FPGA technology are use in KGS series to generate up to 100th harmonic. KGS series supports inter-harmonics editing. Users can program the phase angle and amplitude of the harmonic through the GUI, allowing generate three-phase harmonic/inter-harmonic waveforms independently.

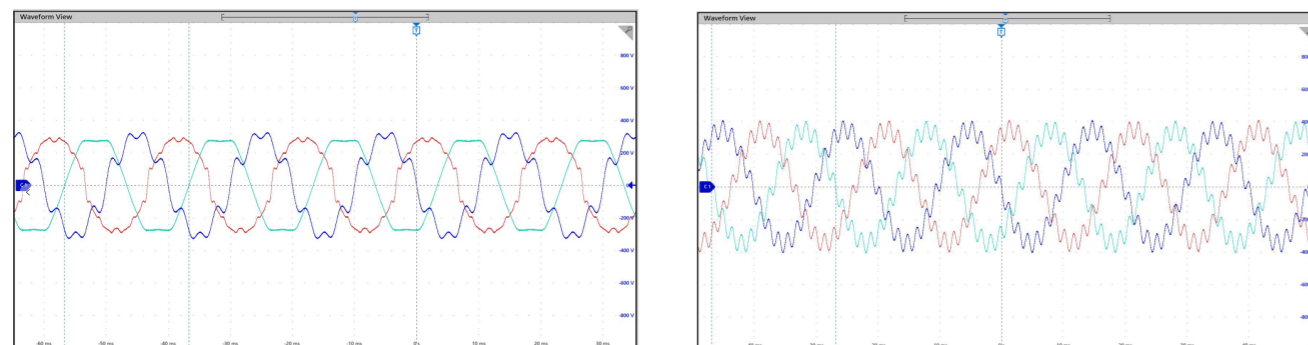

Harmonic Waveform

Inter-harmonic Waveform

• **Fast Dynamic — Voltage drop simulation (LVRT)**

KGS series provides firmware and software support for low/zero voltage ride through tests.

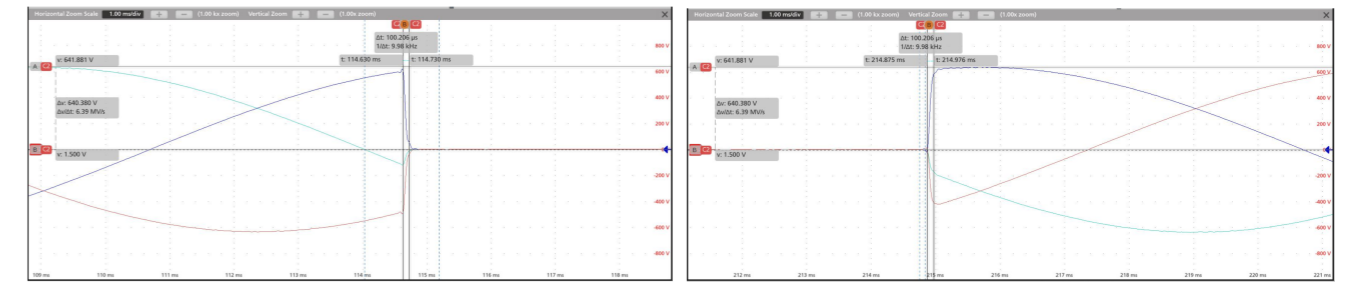

Voltage change (450V→0V) <100us

Voltage change (0V→450V) <100us

Note: above test waveforms are measured under resistive load.

Regenerative AC/DC Load ¹

In the regenerative AC load mode, CR mode, Rectifier mode, and CC/CP phase lead/lag mode are available. **CR mode** is used to simulate three-phase resistive loads, the CR mode and three-phase resistance parameters can be set through the panel and can realize the program of resistance sequence. **Rectifier mode** can be used to simulate non-linear loads, the **CC/CP mode** and CF (setting range: 1.414~3) parameters can be set through the panel. **CC/CP phase lead/lag mode** can simulate sinusoidal current, Constant current CC and constant power CP modes are available to adjust load current or power, phase angle can be set from 90°to -90° simulating the voltage and current conditions under inductive and capacitive loads.

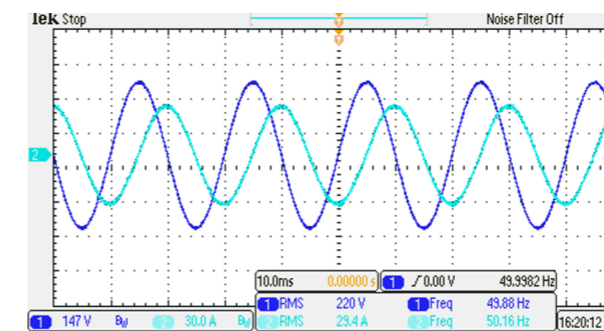

Angle = +90°

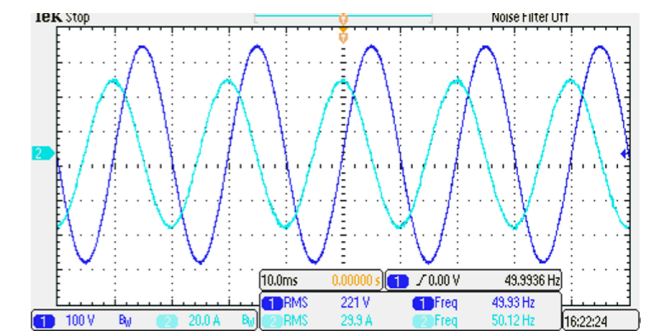

Angle = -90°

¹ KGS can still output a stable and reliable current waveform even when the input voltage is not pure sine wave or the sine wave has large distortion.

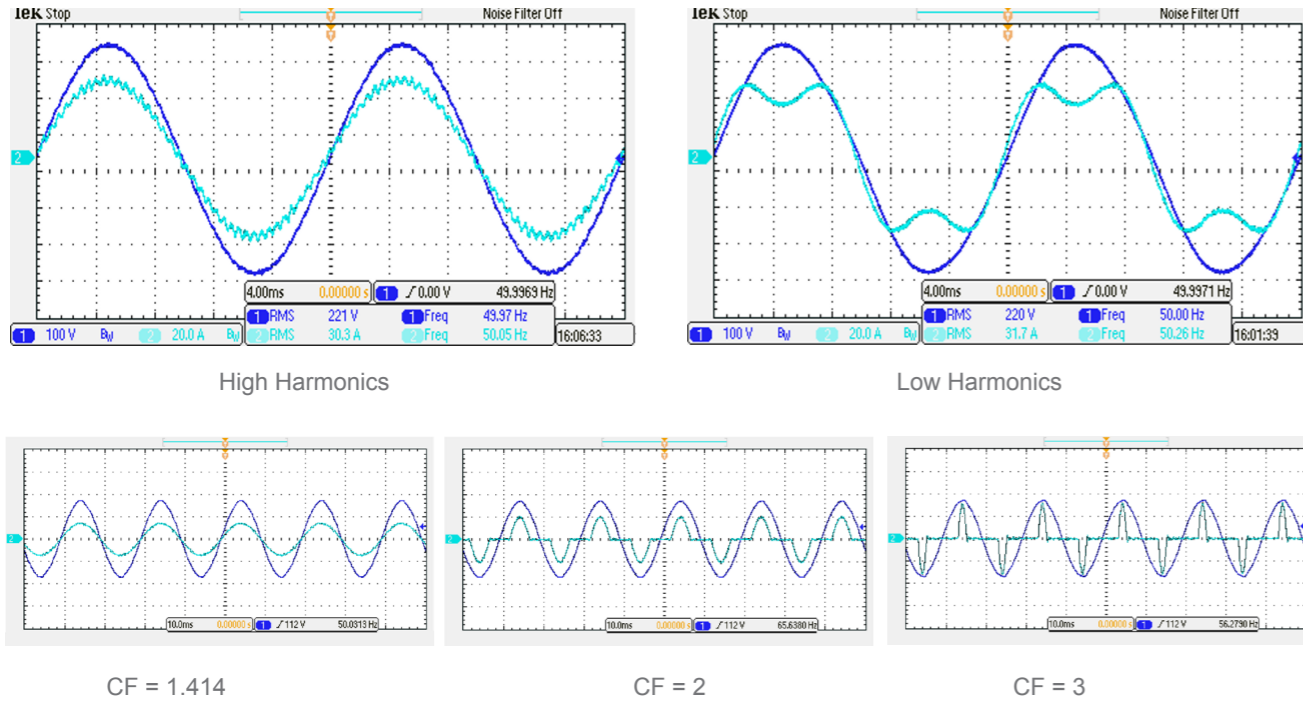

Regenerative DC electronic load mode is also available with the KGS series, which provides CV, CC, CP, and CR operation modes.

Current Source Mode

The KGS Series uses true current feedback control when working in Current source mode. It is different from power supplies using voltage feedback with constant current mode, which is called voltage controlled current. The voltage controlled current power supplies maintain setting current value by adjusting output voltage and have relatively long response time to sudden impedance changes, which typically results in dynamic current overshoot or undershoot as the load impedance changes. KGS series working in CC mode does not have such problem and will always maintain the current at the setting value, regardless of transient load conditions.



Power Amplifier Function (analog signal input)

The KGS is a power amplifier with high dynamic response and bandwidth. The delay between input external signal and power source output $\leq 20 \mu\text{s}$.

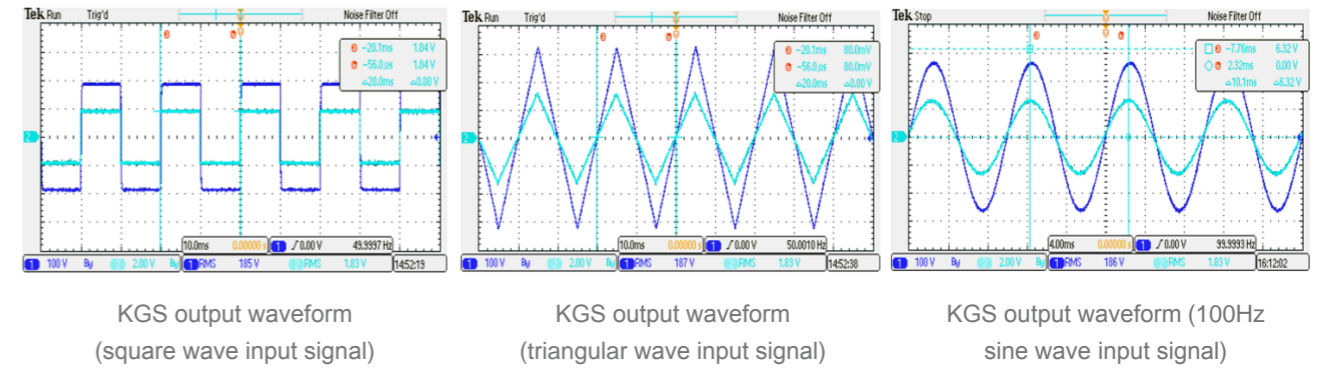

Avionics Power Line Simulation

The KGS series meets the requirements of avionics bus simulation, and can simulate working conditions including normal working, power interruption (conversion), abnormal power supply, emergency power supply, startup, power failure, etc., to meet the requirements of MIL-STD-704 and other test regulations. In addition, remote control interfaces and SCPI command language are provided for easy integration into ATE systems.

RLC Load Simulation

The KGS series provides RLC load simulation mode, which simulates the impedance of the combinations of R, L and C components. The three phases are independently programmable, and the R, L, C values can be set respectively.

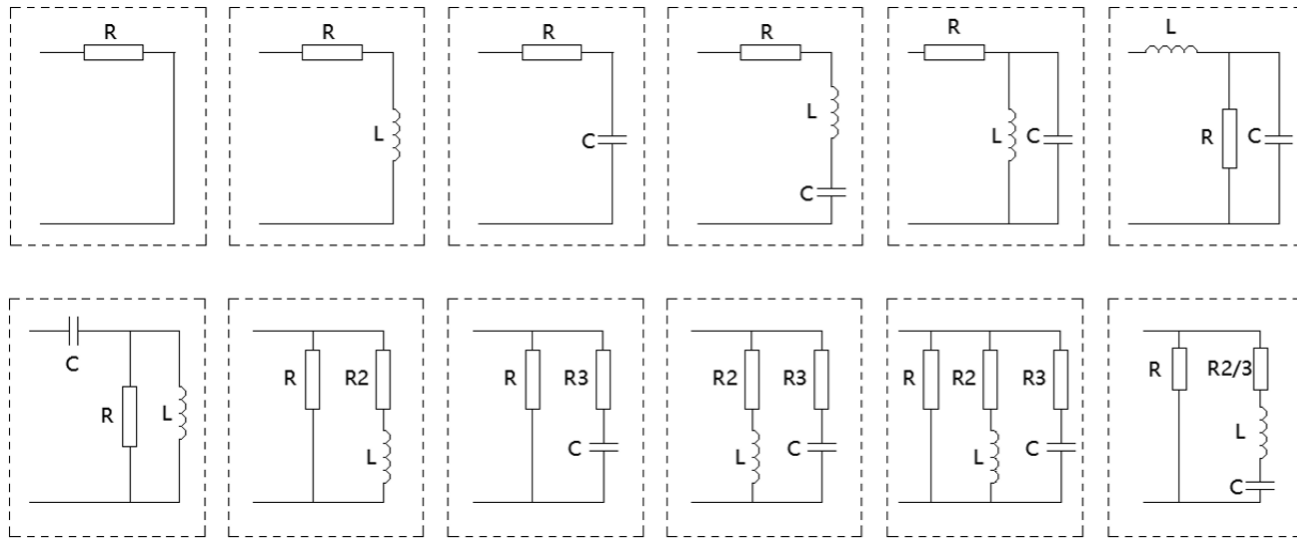

RCD Load Simulation

KGS provides RCD non-linear load simulation function for testing UPS power supplies, inverters, etc.

The KGS has four built-in RCD electrical topologies, 3-phase independently programmable, with individually programmable R, L and C parameter values.

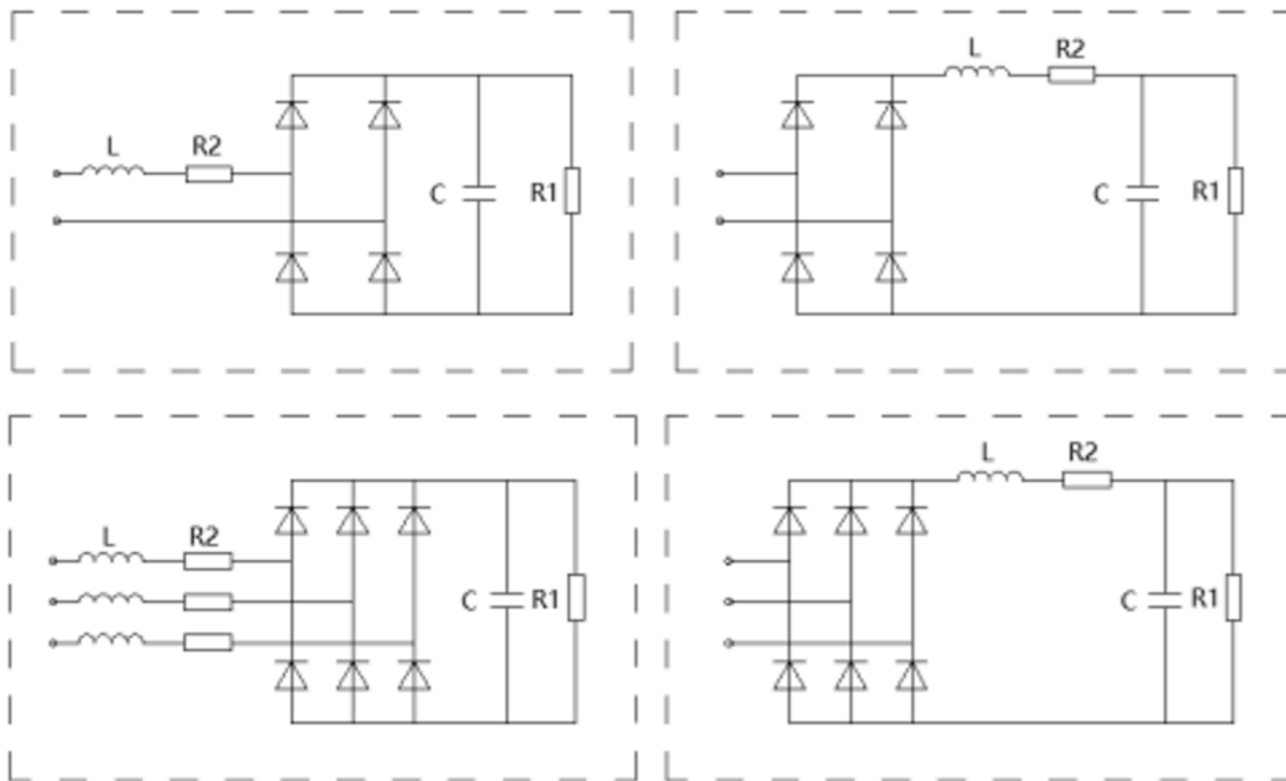

Bi-Polar DC Source (-BP option)

The KGS series also provides bipolar DC output, and in this mode, phase A is used as POS+ output, phase B is used and NEG- output, the Neutral terminal is used as PE. The output power of KGS 45-BP is 30KW in bipolar output mode, and the voltage range is +/-600V, the current range is +/-70A.

Graphical User Interface

GUI software is installed in front touch panel, which uses Windows OS. The software provides following functions:

- Output limits and settings
- Sequence output settings

The output phase voltage, angle, frequency, ON/OFF phase angle, dwell time, switching time and other parameters of the power supply can be set.

- Generate harmonic and inter-harmonic waveforms

Up to 100th harmonic waveform generation, inter-harmonic generation

- Real time display measurements: voltage, current, power, etc.
- Capture, display and save output voltage and current waveforms
- Display power source faults

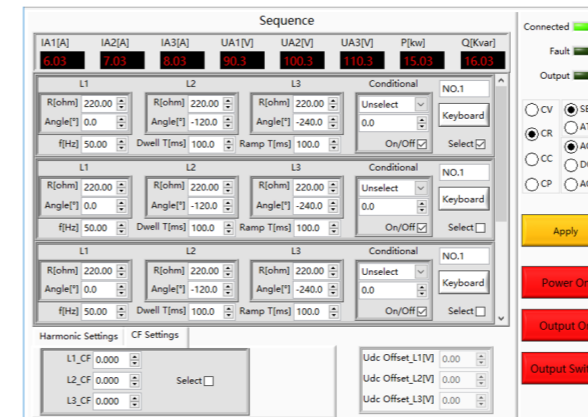

Sequence Programming

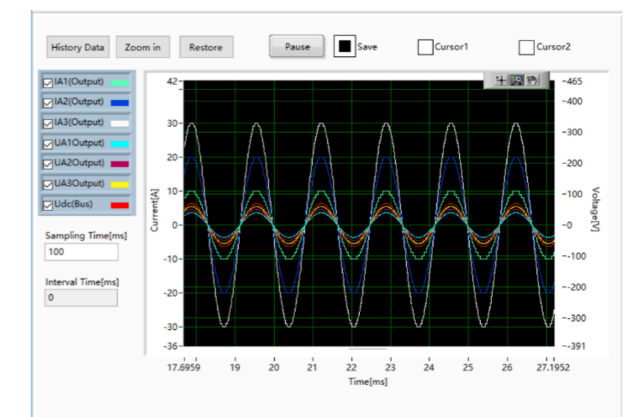

Waveform Display

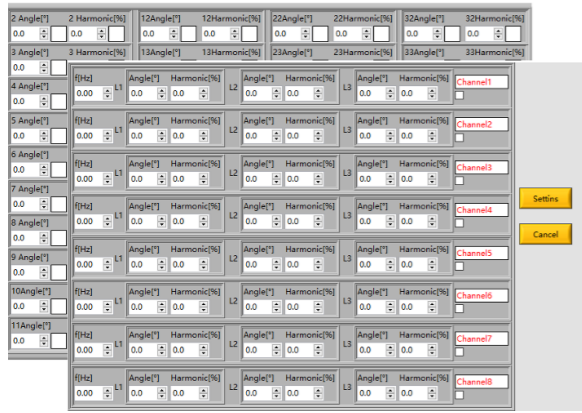

Harmonic/Inter-harmonic editing

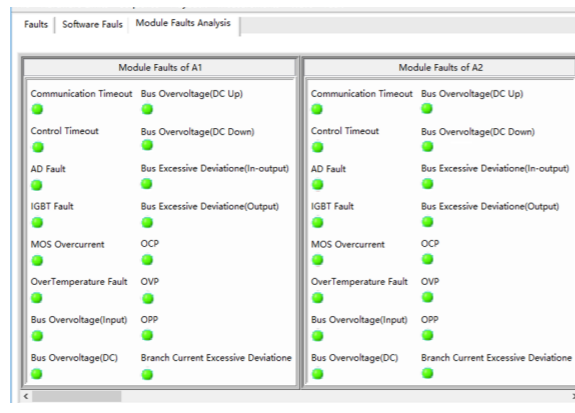

Fault Display

Block Diagram

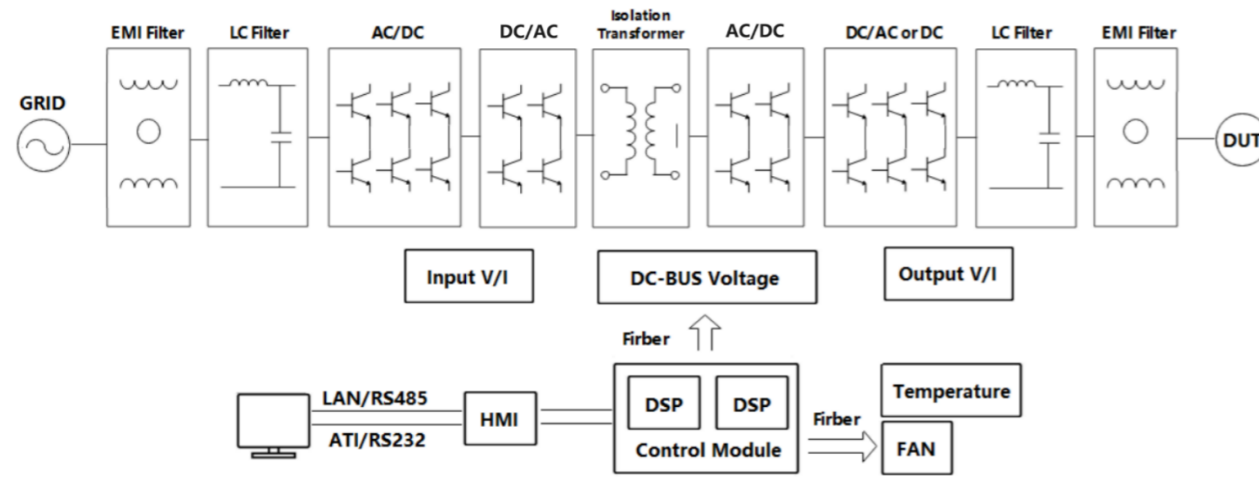

General Specification

AC input	
Voltage	3P+N+PE, 380VLL±10%(std)
Frequency	47-63Hz
Efficiency	≥85%
Power Factor	0.99
THDi	<3%FS

Output	
Output Modes	AC, DC, or AC+DC
Power Level	From 15kVA to 1080kVA
Load Regulation	0.1%FS
Line Regulation	0.1%FS
AC Output	
Voltage & Current Range (max output per 15KW module)	Max 450V L-N, 70A @ DC~65Hz Max 375V L-N, 70A @ 65~1000Hz Max 350V L-N, 70A @ 1000~2000Hz Max 250V L-N, 60A @ 2000~3000Hz Max 150V L-N, 50A @ 3000~5000Hz
Phase Angle Range	Phase B/C relative to phase A, 0.0~360.0°
Frequency Range	DC -5000Hz
Small signal bandwidth	10kHz
THD	<0.3%FS @15~50Hz (measured at 250V L-N, Resistive Load) <0.4%FS @50~500Hz (measured at 250V L-N, Resistive Load) <0.7%FS @500~2000Hz (measured at 250V L-N, Resistive Load) <1%FS @2000~4000Hz (measured at 100V L-N, Resistive Load) <2%FS @4000~5000Hz (measured at 100V L-N, Resistive Load)
Harmonic Generation	Up to 100th @50/60Hz
	Harmonic accuracy: 1%FS
	Within 50th: total harmonic content ≤ 100%

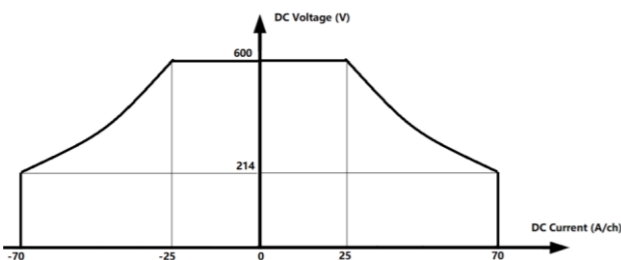
	Within 100th: total harmonic content $\leq 30\%$
Voltage Slew Rate	5V/us
Current Slew Rate	0.5A/us
Current Peak Factor	1 ~ 3
Power Accuracy	DC~45Hz: 0.3%FS 45~70Hz: 0.1%FS 70~2KHz: 0.3%FS
Voltage Accuracy	DC~45Hz: 0.2%FS 45~70Hz: 0.1%FS 70~2KHz: 0.2%FS
Current Accuracy	DC~45Hz: 0.3%FS 45~70Hz: 0.1%FS 70~2KHz: 0.3%FS
Frequency Accuracy	0.01%FS+0.01Hz
Phase Angle Accuracy	DC~45Hz: $<1^\circ$ 45~70Hz: $<0.1^\circ$ 70~2KHz: $<1^\circ$
Power Resolution	0.001kW
Voltage Resolution	0.1V
Current Resolution	0.01A
Frequency Resolution	0.01Hz (~100Hz), 0.05Hz (>100Hz)
DC Output	
Voltage & Current Range (max output per 15KW module)	0~600V, $\pm 70A/ch$ 
Voltage Accuracy	0.1%FS

Current Accuracy	0.1%FS
Voltage Ripple	0.1%FS
AC+DC Mode	Max Power, Voltage and Current are the same as DC Mode
RLC/RCD Load Simulation²	
R	Range: 0.1~1000 Ω . Resolution: 0.1 Ω . Accuracy: $\pm 0.1\%$ FS
L	Range: 0.1~5000mH. Resolution: 0.5mH. Accuracy: $\pm 0.1\%$ FS
C	Range: 0.001~5mF. Resolution: 0.1mF. Accuracy: $\pm 0.1\%$ FS
Others	
Standard Interface	LAN/RS485/AT1
Protection	OVP, OCP, OPP, OTP
IP Ingress protection	IP21
CE Conformity	EN 62040-1, EN 62040-2
Cooling	Forced Air Cooling
Temperature	Operating: 0~40 $^\circ$ C Storage: -20~85 $^\circ$ C
Operating Humidity	20-90%RH (None Condensing)

² The accuracy measured at 50/60Hz

Standard Model Specification

Model	Output Power	Max AC Output	Max DC Output	Dimension (W*D*H, mm)	Weight (kg)
KGS 15	15kVA	450V L-N, 70A	0~600V, $\pm 70A$	800*900*1100	300
KGS 45	45kVA	450V L-N, 70A/ph	0~600V, $\pm 70A$	800*900*1500	460
KGS 90	90kVA	450V L-N, 140A/ph	0~600V, $\pm 140A$	900*900*2200	900
KGS 135	135kVA	450V L-N, 210A/ph	0~600V, $\pm 210A$	1600*900*1800	1050

KGS 180	180kVA	450V L-N, 280A/ph	0~600V, ±280A	1600*900*2200	1200
KGS 270	270kVA	450V L-N, 420A/ph	0~600V, ±420A	2400*900*2200	1800
KGS 360	360kVA	450V L-N, 560A/ph	0~600V, ±560A	3200*900*2200	2400
KGS 450	450kVA	450V L-N, 700A/ph	0~600V, ±700A	4000*900*2200	2900
KGS 540	540kVA	450V L-N, 840A/ph	0~600V, ±840A	4800*900*2200	3600

Note:

1. Total weight < 1400KG, the cabinet bottom is wheel structure; otherwise, it is channel steel structure.
2. The output current above is the 3-phase output current, when configured as single-phase output the output current becomes three times.

Options

- BP Bi-Polar DC Source
- HV900 Increase output voltage to 900V L-N, consult factory

AC Input Configuration ³

Please specify the input voltage (L-L)

/380, Input Voltage 380V±10%, 3-phase

/400, Input Voltage 400V±10%, 3-phase

/480, Input Voltage 480V±10%, 3-phase

Model Configuration

KGS AAA-BBB/CCC

AAA: Power, kVA

BBB: Option

CCC: Input configuration

³ other AC input is available, please consult factory.

About BriPower

Bridge Technology is a company focusing on business of **power supplies and test systems for new energy applications**. We are devoted to providing high quality products and solutions for customers.

Bridge Technology has a **top-class R&D team** in China, works on modularization and standardization power supplies and systems. We have sales, technical support, R&D and manufacture in Shanghai, Nanjing and Chengdu.

Nanjing Bridge New Energy Technology was founded on Jan 12th, 2016, focusing on R&D and manufacturing BriPower brand power systems, including bi-directional AC sources for grid simulation, bi-directional DC sources for battery simulation, and regenerative loads. The BriPower AC&DC power systems are widely used in new energy and related fields. **BriPower is valuable to customer especially High Power and High Voltage.**

- Factory: Nanjing Bridge New Energy Technology Co., Ltd
- Sales Company: Shanghai Bridge Electronic Technology Co., Ltd
- General information: info@bridgetech.cn
- Technical Support: support@bridgetech.cn
- Repair & Calibration: service@bridgetech.cn
- Tel: 40010-18618
- Int'l Sales: contact@bridgetech.com.sg

